

**Dowel Pin mit Retentionen**  
*Dowel Pin with Retentions*

**Beschreibung:** Dowel Pin aus Messing mit Retentionen (Kopf Ø: 2,0 mm)  
**Anwendungsbereich:** Zur Modellherstellung, und Fixation von Kunststoffstümpfen z.B. bei Konuskronen.

**Description:** Brass Dowel Pin with retentions (head Ø: 2,0 mm)

**Field of application:** For preparing models and for fixation of plastic stumps for example at taper crowns.

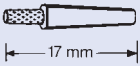
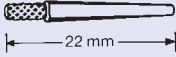
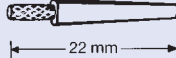
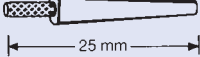

Bestellnummer Order Number	Maße / Abbildung Measurement / Picture	Verpackungseinheit Unit
355/0	 17 mm	1.000 St. Packung 1.000 pcs. packet
355/1	 22 mm	1.000 St. Packung 1.000 pcs. packet
355/2	 22 mm	1.000 St. Packung 1.000 pcs. packet
355/3	 25 mm	1.000 St. Packung 1.000 pcs. packet



**Dowel Pin mit Steckstift**  
*Dowel Pin with Spike*

**Beschreibung:** Dowel Pin aus Messing mit Retentionen und Steckstift (Kopf Ø: 2,0 mm)  
**Anwendungsbereich:** Durch den Steckstift ist bereits vor dem Ausgießen des Zahnabdruckes aus Silikon oder Alginate eine sehr gute Fixation des Pins möglich.

**Description:** Brass Dowel Pin with retentions and spike (head Ø: 2,0 mm)

**Field of application:** Already, before filling up the dental casting of silicone or alginate, a very good pin fixation by the spike is possible.

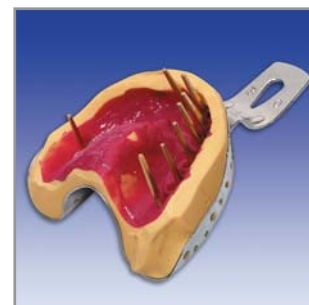

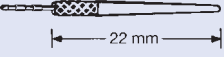
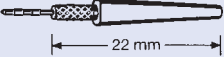
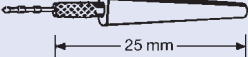
Bestellnummer Order Number	Maße / Abbildung Measurement / Picture	Verpackungseinheit Unit
356/1	 22 mm	1.000 St. Packung 1.000 pcs. packet
356/2	 22 mm	1.000 St. Packung 1.000 pcs. packet
356/3	 25 mm	1.000 St. Packung 1.000 pcs. packet



**Dowel Pin mit Metallhülse / nur ein Pin pro Stumpf erforderlich.**  
**Dowel Pin with Brass Sleeve / only one pin per stump is necessary.**

**Beschreibung:** Dowel Pin aus Messing mit Metallhülse und Retentionen, mit Retentionen und Steckstift oder ohne Retentionen und Steckstift (Kopf Ø: 2,0 mm).

**Anwendungsbereich:**

**Mit Retention:** Präzises fixieren des Pins im Abdruck vor dem Abbinden des Gipses.

**Mit Steckstift:**

Zum genauen fixieren von einzelnen Zahnstümpfen vor dem Ausgießen des Abdruckes.

**Ohne Retention und Steckstift:** Der Pin wird erst nach dem Beschleifen des Zahnkranzes in die entsprechenden Bohrungen des Gipsabdruckes geklebt.











**Description:** Brass Dowel Pin and Brass Sleeve with retentions, with retentions and spike or without retentions and spike (head Ø: 2,0 mm).

**Field of application:**

**With retention:** For precise fixation of the pin in the casting, before the plaster sets.

**With spike:** for precise fixation of single tooth stumps, before filling up the casting.

**Without retention and spike:** Only after abrading the plaster casting the pin is stuck into the drilling of the casting.

Bestellnummer Order Number	Maße / Abbildung Measurement / Picture	Verpackungseinheit Unit
359	   ←11 mm→	100 St. Packung 100 pcs. packet
359/0	   ←8 mm→	100 St. Packung 100 pcs. packet
360	   ←11 mm→	100 St. Packung 100 pcs. packet
361	   ←11 mm→	100 St. Packung 100 pcs. packet



### Bogenpin / Brass Arched Pin



**Beschreibung:** Bogenpin aus Messing, spitz / flach-spitz (Kopf Ø: 2,0 mm)

**Anwendungsbereich:** Zum Fixieren von komplizierten Zahnstumpfpforten im Abdruck, z. B. bei ungleichmässiger Stellung oder wenig Platz der Frontzähne im Unterkiefer. Der Gips kann ohne Probleme am Bogenpin vorbei in den Abdruck fließen.

**Description:** Brass Arched Pin sharp / flat-sharp (head Ø: 2,0 mm).

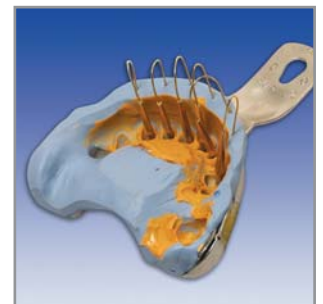
**Field of application:** For fixation of complicated tooth stumps in the casting, for example due to irregular position and little space of the front teeth in the lower jaw. The plaster can flow along the Brass Arched Pin into the casting without problems.



Bestellnummer Order Number	Maße / Abbildung Measurement / Picture	Verpackungseinheit Unit
365/1		100 St. Packung 100 pcs. packet
365/2		100 St. Packung 100 pcs. packet

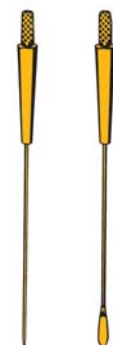

Modell Pin  
Model Pin

**Beschreibung:** Modell Pin aus Messing mit Kunststoffhülse, kurz / mittel / lang (Kopf Ø: 2,0 mm).  
**Anwendungsbereich:** Zur Herstellung von Gipsmodellen mit abnehmbaren Zahnreihen bzw. Einzelstümpfen.

**Description:** Brass Model Pin with Plastic Sleeve, short / middle / long (head Ø: 2,0 mm).  
**Field of application:** For production of plaster models with removable tooth lines or single stumps.

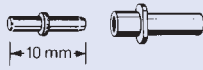
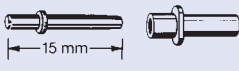
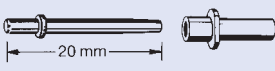

Bestellnummer Order Number	Maße / Abbildung Measurement / Picture	Verpackungseinheit Unit
-------------------------------	---	----------------------------

380/1 G		1.000 St. Packung 1.000 pcs. packet
380/2 G		1.000 St. Packung 1.000 pcs. packet
380/3 G		1.000 St. Packung 1.000 pcs. packet





Modell Pin  
Model Pin

**Beschreibung:** Modell Pin aus Messing mit Metallhülse (Kopf Ø: 2,0 mm).  
**Anwendungsbereich:** Zur Herstellung von Gipsmodellen mit abnehmbaren Zahnreihen bzw. Einzelstümpfen.

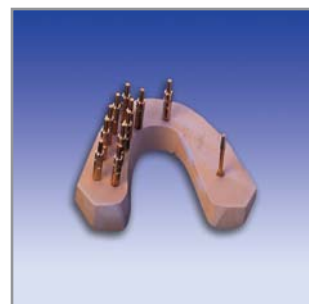
**Description:** Brass Model Pin with Metal Sleeve, short / middle / long (head Ø: 2,0 mm).  
**Field of application:** For production of plaster models with removable tooth lines or single stumps.



Bestellnummer Order Number	Maße / Abbildung Measurement / Picture	Verpackungseinheit Unit
-------------------------------	---	----------------------------

385		1.000 St. Packung 1.000 pcs. packet
386		1.000 St. Packung 1.000 pcs. packet
387		1.000 St. Packung 1.000 pcs. packet



**Modell Pin zur Herstellung von "Zeisser-Modellen"**  
*Model Pin for making "Zeisser-Models"*

**Beschreibung:** Modell Pin aus Messing kurz (Kopf Ø: 2,0 mm).

**Anwendungsbereich:** Zur Herstellung von "Zeisser-Modellen".

**Description:** Model Pin of brass short (head Ø: 2,0 mm).

**Field of application:** For production of "Zeisser-Models".



Bestellnummer Order Number	Maße / Abbildung Measurement / Picture	Verpackungseinheit Unit
-------------------------------	---	----------------------------

Z1	(kurz, short) 	1.000 St. Packung 1.000 pcs. packet
----	---	--

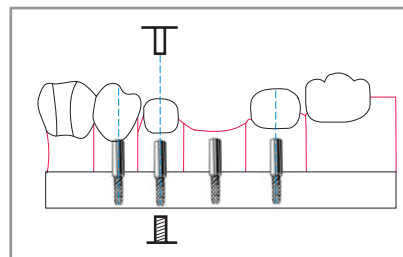

**Hartmetall-Pin-Bohrer**  
*Tungsten Carbide Pin Drill*

**Beschreibung:** Pin-Bohrer aus Hartmetall  
**Anwendungsbereich:** Zur Herstellung aller Modelle, bei welchen Pins mit einem Kopfdurchmesser von 2,0 mm verwendet werden.

**Description:** Pin Drill of Tungsten Carbide.  
**Field of application:** For preparation of all models using pins with a head diameter of 2,0 mm.

Bestellnummer Order Number	Maße Measurement	Verpackungseinheit Unit
-------------------------------	---------------------	----------------------------

C 381	Kopf Ø: 2,0 mm Schaft Ø: 3,0 mm Länge: 34,5 mm	1 Stück
	Head Ø: 2,0 mm Shank Ø: 3,0 mm Length: 34,5 mm	1 piece



**Hartmetall-Pin-Bohrer**  
*Tungsten Carbide Pin Drill*

**Beschreibung:** Pin-Bohrer aus Hartmetall.  
**Anwendungsbereich:** Zur Herstellung aller Modelle, bei welchen Pins mit einem Kopfdurchmesser von 1,6 mm verwendet werden. (RISA-Pin Art. Nr. 385).

**Description:** Pin Drill of Tungsten Carbide.  
**Field of application:** For preparation all models using pins with a head diameter of 1,6 mm. (RISA-Pin Art. No. 385).

Bestellnummer Order Number	Maße Measurement	Verpackungseinheit Unit
C 388	Kopf Ø: 1,6 mm / Head Ø: 1,6 mm Schaft Ø: 3,0 mm / Shank Ø: 3,0 mm Länge: 32,0 mm / Length: 32,0 mm	1 Stück / 1 piece
C 389	Kopf Ø: 1,6 mm / Head Ø: 1,6 mm Schaft Ø: 3,0 mm / Shank Ø: 3,0 mm Länge: 35,0 mm / Length: 35,0 mm	1 Stück / 1 piece
C 390	Kopf Ø: 1,6 mm / Head Ø: 1,6 mm Schaft Ø: 3,0 mm / Shank Ø: 3,0 mm Länge: 38,0 mm / Length: 38,0 mm	1 Stück / 1 piece

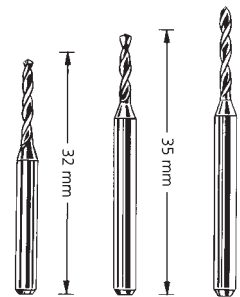



**Retentionsringe**  
*Retention Rings*

**Beschreibung:** Retentionsringe.  
**Anwendungsbereich:** Zum Sockeln von Gipspartien zwischen und neben den herausnehmbaren Stümpfen des Sägemodells. Zum Sockeln von kompletten Zahnkränzen.

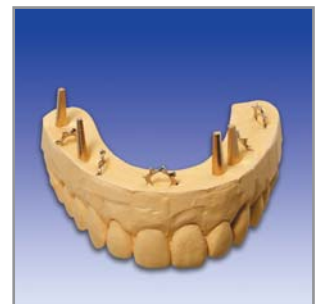
**Description:** Retention Rings  
**Field of application:** For anchoring of plaster parts between and beside the removable stumps of the saw model. For anchoring of complete tooth models.



Bestellnummer Order Number	Abbildung Picture	Verpackungseinheit Unit
353 Messing / Brass		1.000 St. Packung 1.000 pcs. packet
354/1 vernickelt / nickel plated		1.000 St. Packung 1.000 pcs. packet
354/2 vernickelt / nickel plated		1.000 St. Packung 1.000 pcs. packet

