







Filz- und Gummikegelträger
Felt and Rubber Cone Holder

Beschreibung: Filz- und Gummikegelträger.
Anwendungsbereich: Für elastische Polierspitzen und Filzkegel.

Description: *Felt and Rubber Cone Holder.*
Field of application: *For flexible polishers / felt and rubber polishers.*

Bestellnummer <i>Order number</i>	Abbildung <i>Picture</i>	Technische Daten / <i>Technical Data</i>	
		Schaft Ø <i>Shank Ø</i>	Kopf Ø ISO <i>Head Ø ISO</i>
301 RS HP		2,35 mm	
301-3mm RS HP		3,00 mm	
301a RS HP		2,35 mm	
301a-RA RS		2,35 mm	
310 RS HP		2,35 mm	
310-RA RS		2,35 mm	
310a RS HP		2,35 mm	



Verpackungseinheit / *Unit*: 100 Stück / 100 pcs.



Scheibenträger
Mandrel

Beschreibung: Träger "303".
Anwendungsbereich: Für Scheiben und Kreissägen aller Art.

Description: Mandrel "303".
Field of application: For discs and circular saws of all types.

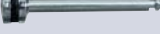
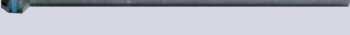
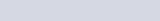
Bestellnummer Order number	Abbildung Picture	Technische Daten / Technical Data	
		Schaft Ø Shank Ø	Kopf Ø ISO Head Ø ISO
303 N HP		2,35 mm	050
303-RA N		2,35 mm	050
303 RS HP		2,35 mm	050
303-RA RS		2,35 mm	050
303-3mm N HP		3,00 mm	050
303-3mm RS HP		3,00 mm	050
303-1/2-RS HP		2,35 mm	035
303-1/2-RA RS		2,35 mm	035

Verpackungseinheit / Unit: 100 Stück / 100 pcs.











Scheibenträger
Mandrel

Beschreibung: Träger "304".
Anwendungsbereich: Für Scheiben und Kreissägen aller Art.





Description: Mandrel "304".
Field of application: For discs and circular saws, all types.

Bestellnummer Order number	Abbildung Picture	Technische Daten / Technical Data	
		Schaft Ø Shank Ø	Kopf Ø ISO Head Ø ISO
304 N HP		2,35 mm	050
304-RA N		2,35 mm	050
304 RS HP		2,35 mm	050
304-RA RS		2,35 mm	050
304-3mm N HP		3,00 mm	050
304-3mm RS HP		3,00 mm	050

Verpackungseinheit / Unit: 100 Stück / 100 pcs.

Beschreibung: Träger "305" "306" "307".
Anwendungsbereich: Für Scheiben und Kreissägen aller Art.

Description: Mandrel "305" "306" "307".
Field of application: For discs and circular saws, all types.





305 N HP		2,35 mm	080
306 N HP		2,35 mm	080
306-3mm N HP		3,00 mm	080
307 N HP		2,35 mm	080

Verpackungseinheit / Unit: 100 Stück / 100 pcs.

Streifenträger
Split Mandrel

Beschreibung: Streifenträger "308".
Anwendungsbereich: Zum Einspannen von Sandpapierstreifen.

Description: *Split Mandrel "308".*
Field of application: *To clamp-in abrasive bands.*

Bestellnummer <i>Order number</i>	Abbildung <i>Picture</i>	Technische Daten / <i>Technical Data</i>	
		Schaft Ø <i>Shank Ø</i>	Kopf Ø ISO <i>Head Ø ISO</i>
308 N HP		2,35 mm	045
308a N HP		2,35 mm	045
308b N HP		2,35 mm	045
308c N HP		2,35 mm	030
308d N HP		2,35 mm	023

Verpackungseinheit / *Unit:* 100 Stück / 100 pcs.

Bürstenträger
BrushHolder

Beschreibung: Bürstenträger "320b N HP".
Anwendungsbereich: Zum problemlosen Einspannen von Bürsten jeder Art. Innen Ø 3,0mm.

Description: *Brush Holder "320b N HP".*
Field of application: *For problem-free clamping of brushes of all types. Inside Ø 3,0mm.*

Bestellnummer <i>Order number</i>	Abbildung <i>Picture</i>	Technische Daten / <i>Technical Data</i>	
		Schaft Ø <i>Shank Ø</i>	Kopf Ø ISO <i>Head Ø ISO</i>
320b N HP		2,35 mm	060

Verpackungseinheit / *Unit:* 100 Stück / 100 pcs.



Reduzierhülsen
Reducing Sleeves

Beschreibung: RISA Reduzierhülsen zum Einspannen von Werkzeugen in Spannzangen.
Anwendungsbereich: Mit den RISA Reduzierhülsen wird der Einsatz jedes HP- und FG-Instruments im Handstück ermöglicht. Dadurch wird eine sachgerechte, sowie uneingeschränkte Instrumentenauswahl gewährleistet.

Description: RISA Reducing Sleeves to clamp instruments into collets.
Field of application: With the RISA Reducing Sleeves you can use every HP- and FG-Instrument in the handpiece. Correct and unlimited selection of instruments is thus assured.

Bestellnummer <i>Order number</i>	Abbildung <i>Picture</i>	Technische Daten / <i>Technical Data</i> Aussen Ø <i>Outside Ø</i>	Innen Ø ISO <i>Inside Ø ISO</i>
317 für HP-Instrumente		3,00 mm	023
318 für FG-Instrumente		2,35 mm	016
319 für FG-Instrumente		3,00 mm	016

Verpackungseinheit / Unit: 10 Stück / 10 pcs.

FG - Adapter
FG Adapters

Beschreibung: RISA FG - Adapter zum Einspannen von FG-Instrumenten im Handstück.
Anwendungsbereich: Mit den RISA FG-Adaptoren wird der Einsatz jedes FG-Instruments auch im Handstück ermöglicht. Dadurch wird eine sachgerechte, sowie uneingeschränkte Instrumentenauswahl gewährleistet.

Description: RISA FG Adapters to clamp FG-Instruments into a handpiece.
Field of application: With the RISA FG-Adapters you can use every FG-Instrument in the handpiece. Correct and unlimited selection of instruments is thus assured.

322 RS HP		2,35 mm
322 RA RS		2,35 mm
323 RS HP		2,35 mm
323 RA RS		2,35 mm

Drehzahl nicht über 15.000 U/min.







Recommended speed not more than 15.000 U/min.

Verpackungseinheit / Unit: 10 Stück / 10 pcs.

Scheibenträger "Moore Snap on off"
Mandrel "Moore Snap on off"

Beschreibung: RISA Scheibenträger "Moore Snap on off" doppelt oder einfach geschlitzt.
Anwendungsbereich: Zum problemlosen Aufsetzen von "Snap on off" Scheiben.
Die Scheiben sitzen absolut fest und sicher auf dem Träger.

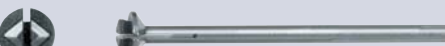
Description: RISA Mandrel "Moore Snap on off" double or single slotted.
Field of application: For problem-free placement of "Snap on off" discs.
The discs remain absolutely firm and safe on the mandrel.

Bestellnummer Order number	Abbildung Picture	Technische Daten / Technical Data	
		Schaft Ø Shank Ø	Kopf Ø ISO Head Ø ISO
330 N HP		2,35 mm	050
331 FG N		1,60 mm	050
332 RA N		2,35 mm	050
333 N HP		2,35 mm	060
333 RS HP		2,35 mm	060
334 RA N		2,35 mm	060
334 RA RS		2,35 mm	060



Verpackungseinheit / Unit: 100 Stück / 100 pcs.



Scheibenträger "Moore Pin hole"
Mandrel "Moore Pin hole"

Beschreibung: RISA Scheibenträger "Moore Pin hole".
Anwendungsbereich: Zum problemlosen Aufsetzen von "Pin hole" Scheiben.
Durch den seitlichen Dorn an der Kappe, oder am Träger wird die Scheibe fixiert und ein Verdrehen oder Verrutschen verhindert.
Die Scheibe sitzt absolut fest und sicher auf dem Träger.

Description: RISA Mandrel "Moore Pin hole".
Field of application: For problem-free put on of "Pin hole" discs. By the lateral punch at the cover, or the mandrel the disc becomes fixation and a distort or get out of place will be prevented.
The disc sit absolutly firm and safe on the mandrel.

Bestellnummer Order number	Abbildung Picture	Technische Daten / Technical Data	
		Schaft Ø Shank Ø	Kopf Ø ISO Head Ø ISO
335 N HP		2,35 mm	060
335 RA N		2,35 mm	060
311 RS HP		2,35 mm	060

Verpackungseinheit / Unit: 100 Stück / 100 pcs.

